

Program summary

WORK SUPPORTS

up to operating pressures
of 500 bar

single and double acting

5 different
body types

maximum load force
from 6 to 102 kN

maximum plunger stroke
from 6 to 20 mm

3 types of operation

metallic wiper edge









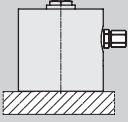
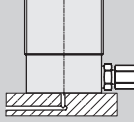
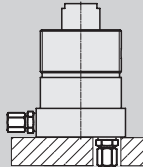
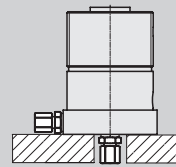
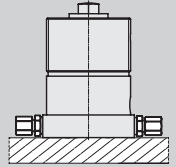
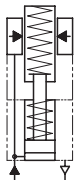
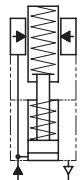
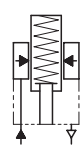
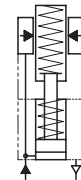
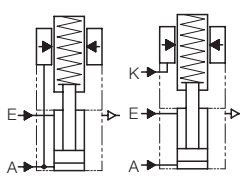

Program summary WORK SUPPORTS

Body design	Block type						Flange at the top		
Hydraulic connection	Pipe thread and drilled channels						Pipe thread and drilled channels		
Functioning	single acting			double acting			single acting		
Self-locking	-			●			-		
Types of operation									
Data sheet	B 1.921			B 1.930			B 1.9503		
Max. operating pressure	500 bar			400/500 bar			500 bar		
Min. operating pressure	100 bar			100 bar			100 bar		
Position monitoring	-			● (pneumatic)			-		
Plunger equipped with	internal thread			contact bolt			contact bolt		
Sealings / Wiper	NBR / NBR			FKM / FKM			NBR / FKM with metallic wiper edge		
Max. operating temperature	+ 100° C			+ 150° C			+ 100° C		
Plunger diameter	16	20	35 mm	16	25	40 mm	20	32	50 mm
Max. load force (1)	7	12.5	28 kN	8	20	40 kN	16.8	42	102 kN
Plunger stroke	6	8	10 mm	8	12	20 mm	12	16	20 mm
Max. flow rate	-	-	-	25	25	25 cm ³ /s	25	35	100 cm ³ /s
Spring contact force (2)	8...10	13.5...17	19.2...24 N	15...22	23...50	55...110 N	15...25	30...60	50...100 N
Pneumatic contact force (3)	20.1	31.4	96.2 N/bar	-	-	-	31	80	196 N/bar
Elastic deformation (4)	3.6	1.7	1.3 μm/kN	0.7	1.5	1.0 μm/kN	3.2	2.1	1.6 μm/kN
Body cross section	60x35	65x45	85x63 mm	70x48	85x63	140x105 mm	70x50	85x63	125x95 mm

Legend: ● Series production
- not available

- (1) at maximum operating pressure
 (2) depending on the stroke
 (3) for versions with spring return
 the pneumatic contact force will be reduced by the spring return force
 (4) at 500 bar operating pressure

Round body	Round body with external thread			
Pipe thread	Pipe thread and drilled channels	Pipe thread - at the side or at the bottom		Pipe thread - at the side
				
single acting	single acting	single acting	single acting	double acting
-	-	-	-	-
				
				
B 1.913	B 1.914	B 1.900	B 1.910	B 1.911
500 bar	500 bar	500 bar	500 bar	500 bar
100 bar	100 bar	100 bar	100 bar	100 bar
-	-	-	-	-
contact bolt	internal thread	internal thread	internal thread	contact bolt
NBR / NBR	NBR / NBR	NBR / NBR	NBR / FKM	NBR / FKM
+ 100° C	+ 100° C	+ 100° C	+ 100° C	+ 100° C
25 mm	32 mm	32	40 mm	40 mm
8 kN	20 kN	32	48 kN	48 kN
8 mm	12 mm	16	18 mm	18 mm
25 cm ³ /s	35 cm ³ /s	-	-	70 cm ³ /s
15...30 N	30...60 N	10...90	10...90 N	60...100 N
-	-	-	-	-
1.6 µm/kN	1.3 µm/kN	0.9	0.9 µm/kN	1 µm/kN
Ø 65 mm	M68x2 mm	M68x2	M78x2 mm	M78x2 mm



Threaded-body type				
<p>Drilled channels</p>	<p>Drilled channels</p>	<p>Drilled channels</p>		
single acting	single acting	single acting		
-	-	-		
B 1.9401	B 1.942	B 1.9501		
500 bar	500 bar	500 bar		
100 bar	100 bar	100 bar		
-	-	-		
contact bolt	contact bolt	contact bolt		
NBR / FKM with metallic wiper edge	NBR / FKM with metallic wiper edge	NBR / FKM with metallic wiper edge		
+ 100° C	+ 100° C	+ 100° C		
16 mm	20 mm	20	32	50 mm
6.5 oder 9.5 kN	15 oder 20 kN	16.8	42	102 kN
8 oder 15 mm	10 oder 15 mm	12	16	20 mm
25 cm ³ /s	25 cm ³ /s	25	35	100 cm ³ /s
7...33 N	18...32 N	15...25	30...60	50...100 N
20 N/bar	31 N/bar	31	80	196 N/bar
3.5 µm/kN (6.5 kN) 4 µm/kN (9.5 kN)	2.7 µm/kN	4.5	2.8	1.8 µm/kN
M30x1.5 mm	M40x1.5 mm	M45x1.5	M60x1.5	M90x2 mm



Application

Hydraulic work supports are used to provide a self-adjusting rest for the workpiece during the machining operations. They compensate the workpiece surface irregularities, also vibration and deflection under machining loads.

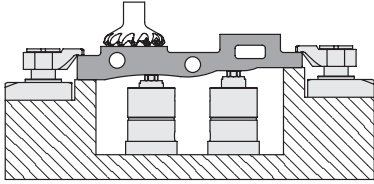

Single or double acting

To reduce the dimensions and the expenses for the control, most of the work supports are single acting with spring return of the support plunger.

Double-acting elements offer the advantage that the support plunger can be returned to the off-position within a precisely defined time.

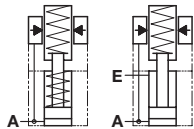

A: Extending and locking
E: Retracting and unlocking

Types of operation

For the support plunger there are 3 types of operation:

Off-position extended

The support plunger is pushed in by the workpiece against the spring force.

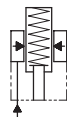

Off-position retracted

The support plunger extends pneumatically and returns by spring force.

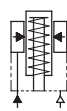

Off-position retracted

The support plunger extends hydraulically with spring force and returns by spring force or hydraulically.

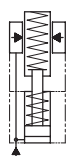

Contact force

The workpiece must not be deformed by the contact of the support plunger. Therefore the contact is made with spring force or pneumatically. Depending on the size the spring forces are between 8 and 100 N. The spring force is the smallest, when the distance between contact bolt and workpiece is the largest.

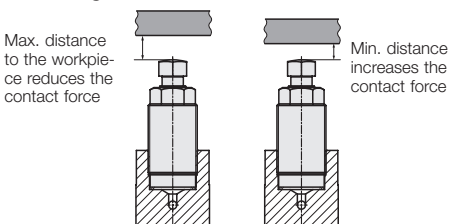

With pneumatic operation the contact force can be precisely adapted by a pneumatic pressure reducing valve. The pneumatic connection serves at the same time as connection for positive air pressure protection

Mounting position

The work supports function in any mounting position. The technical data are only valid for the vertical mounting position. Due to the low spring forces the weight of the support plunger and the contact bolt can influence the contact force and speed.

Function with locking bush

In the body of the work support a thin-walled locking bush is integrated, which locks cylindrically around a movable support plunger when pressurising the element with hydraulic oil. This function requires a minimum operating pressure of 100 bar. After depressurising the support plunger is again freely-movable.

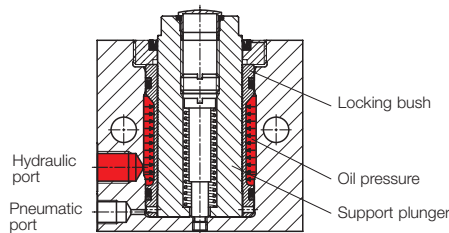

Function with self-locking

In the body of the work supports an additional support plunger is installed that locks a movable support plunger when pressurising the element. This function requires a minimum operating pressure of 100 bar. After depressurising the support plunger remains locked. For unlocking a second hydraulic port must be pressurised, i.e. this element can only be operated in the double-acting mode.

Wiper

All work supports are equipped with wipers for the support plunger. Some versions have a metallic wiper edge to protect the wiper against rough and hot swarf.

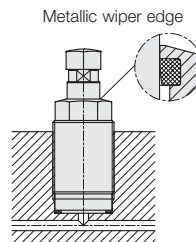

Venting of the spring area

All work supports, where the support plunger contacts the workpiece by spring force, must be vented (exception B 1.940). Especially when using coolants a venting port is imperative to avoid that the coolants will be sucked in into the interior of the work support. In the case of non-compliance troubles of functioning can occur.

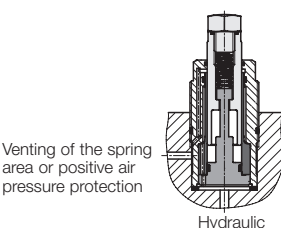

Positive air pressure protection

The safest protection against penetration of liquids and particles is the connection of positive air pressure protection. This is possible for all work supports with vent port. The air pressure must not exceed 0.2 bar.

Position monitoring

Pneumatic position monitoring is possible for work supports as per data sheet B 1.930.

Maximum flow rate

If the flow rate is too high, the oil pressure increases so quickly that the support plunger will be locked before contacting the workpiece. In the case of this malfunction the flow rate has to be throttled.

The admissible flow rate is indicated on the corresponding data sheet.

If several work supports are connected to one line, the admissible pump flow rate is the total of the individually admissible flow rates:

$$V_{adm. pump} \leq n * V_{adm. support}$$

Throttle the flow rate

If the pump flow rate is higher than the admissible flow rate for the work support, throttling has to be effected in the supply line.

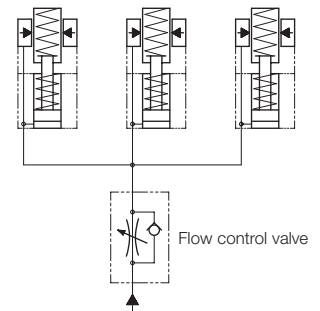

Air bleeding

Air in the oil can considerably prolong the clamping time. Work supports require only a very small oil volume for their operation. Since the hydraulic oil in the connecting line is nearly not moved, careful bleeding is required. If bleeding screws are not available, in the case of drilled channels screw plugs should be provided at the highest and remotest point. Attention! Bleed always at low pressure.

Minimum operating pressure

To bridge the clearance between support plunger and locking bush an oil pressure of 25 to 50 bar is required. The minimum operating pressure of 100 bar already guarantees remarkable holding forces.

Maximum operating pressure

The maximum operating pressure of all work supports is 500 bar. At this pressure the highest load will be obtained. (see diagram „Admissible load force“)

Maximum load force

Work supports can only compensate the maximum load force with a maximum operating pressure of 500 bar.

The admissible load forces with other pressures can be taken from the load force diagrams in the data sheets.

Admissible load force F as a function of the operating pressure p

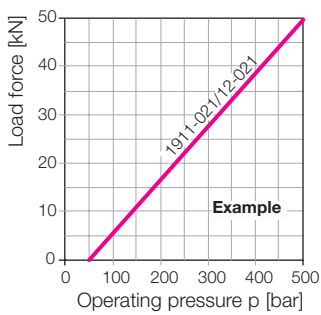

Overload

If the forces indicated in the load force diagram are exceeded by more than 10%, the support plunger can yield.

Side loads

Work supports compensate only forces in the direction of the plunger axis.

If side loads will be introduced into the support plunger, the thin-walled locking bush deforms so that the exact position of the workpiece is no longer guaranteed. That means that the side loads generated during machining have to be compensated by fixed workpiece supports or by horizontal stops.

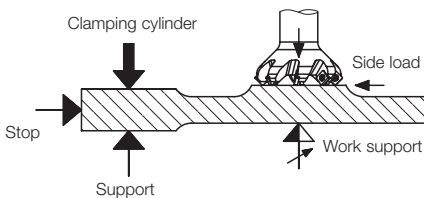

Elastic deformation

Work supports have such as other steel components an elastic behaviour, i.e. they yield in case of load.

The below diagram shows the elastic deformation of a work support with load.

The comparison with a threaded screw jack used for support shows better results for the work supports.

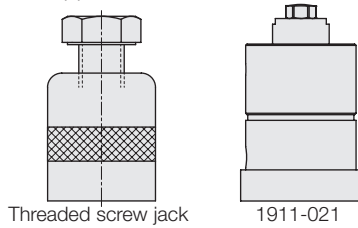

Max. elastic deformation s as a function of support force F

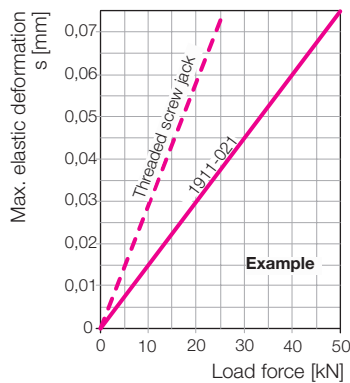

Contact bolts

Most of the work supports are delivered with a contact bolt in the support plunger. This contact bolt has a dome-head and hardened contact surface.

Attention! Never use the work support without contact bolt, since penetrating dirt and liquids impede the function.

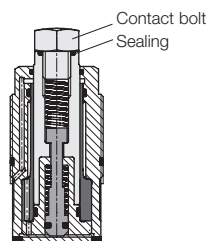

Special contact bolts

When using special contact bolts the following has to be considered:

1. The contact surface shall be hard and slightly dome-head so that it contacts safely the workpiece even in the case of uneven surfaces.
2. A plane contact surface can only be realised with a swivel contact bolt. However you have to reckon with a higher elastic compliance with load since the swivel contact bolt will yield.
3. A contact bolt with point or ribbing has the disadvantage that the points press into the workpiece with load which results in a higher elasticity.

In addition there will be a form fit, so that side loads will be introduced into the work support, which is not admissible.

4. The threaded stem of special contact bolts must have the same length and interior contour as the original. On demand a drawing can be sent.
5. Special contact bolts should have a maximum weight of 100 grams to guarantee the springy contact and the return stroke of the support plunger. Please contact us for the use of heavier or longer contact bolts.

Example

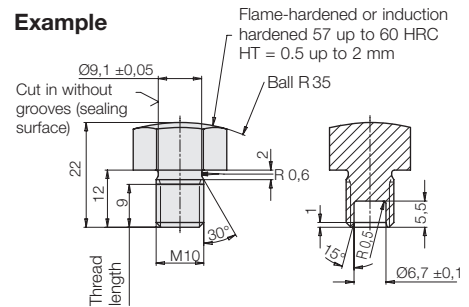

Dimension tolerances

If not otherwise indicated, the general tolerances as per DIN 7168 page 1+2 are valid for the connecting dimension.

Material

- Support plunger: stainless high quality steel chromium-plated to size
- Locking bush: stainless high quality steel
- Cylinder body: free-cutting steel, black-oxide
- Interior parts: nitrocarburized or stainless
- Sealings: NBR or FKM

Römheld GmbH
 Friedrichshütte
 Römheldstraße 1-5
 35321 Laubach, Germany
 Tel.: +49 (0) 6405/89-0
 Fax: +49 (0) 6405/89-211
 E-mail: info@roemheld.de
 www.roemheld.com